

- G** A marine grade digital keypad with simple and reliable stainless steel mechanism from inside the gate.
- G** Auto-latching – close the gate and the latch catches onto the strike plate. To open the gate - from outside enter the code and turn the handle, from inside simply twist the latch.
- G** No power needed – High quality digital keypad ensure long lasting durability.
- G** Internal mechanism is easily reversible for left and right hand gates.



PRODUCT DETAILS

Product code:	Description:
SLDS	Superlatch Digital with shroud

INCLUDED IN THE KIT:

- Digital keypad
- Lock mechanism
- Universally handed lock keep
- 1x rubber gasket (to sit between the keypad and the wooden post)
- 6x fixing screws
- 2x spindles (1x for up to 45mm 1-3/4" thick gates and 1x for up to 75mm (3") thick gates)
- 2x M5 x 60mm (2-3/8") screws (gates up to 45 mm (1-3/4") thick)
- 2x M5 extension pieces (use with M5 screws for gates up to 75mm (3") thick)
- 1x recessed washer (to cover the back of the top hole for the keypad)
- 1x spring to attach to the latch
- 1x spec sheet including drilling guide and installation instructions

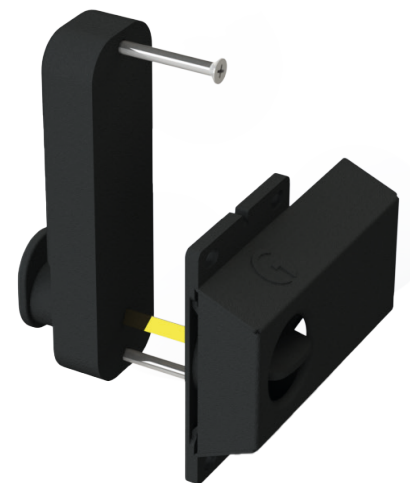
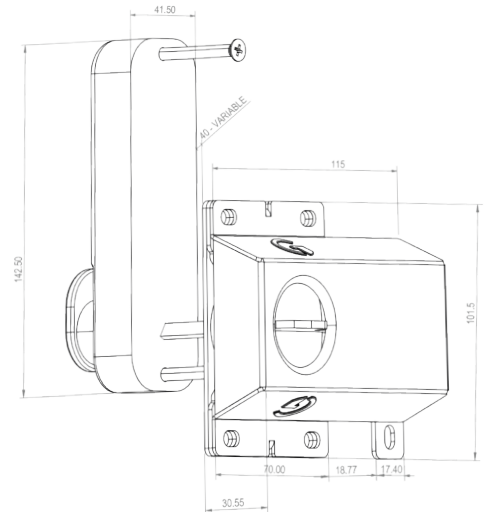

G GATEMASTER

VISIT GATEMASTERLOCKS.COM FOR MORE INFORMATION



HOW TO INSTALL

1. Drill 2 x 9mm (3/8") diameter holes at 130mm (25/64) centres in a vertical line (suggested position 58mm (2-1/4") from the edge of the gate).
2. Drill a 3rd hole 12mm (1/2") diameter, 18mm (47/64") up from the bottom hole.
3. Fix the rubber gasket and outside keypad using 2 x M5 countersunk screws, using the black domed washer under the top screw. The silver extension screws can be used for thicker gates, or the screws may need to be cut down for smaller thicknesses. (Please note – for anything over 75mm (3") thickness you will need to order the extension kit, product code SLDSE140).
4. Insert a rectangular spindle through the gate and fully into the keypad. The spindle should project in between 10 and 15mm (3/8" - 19/32") from the inside face of the gate. The spindle can be cut if the supplied lengths do not fall within these tolerances.
5. Assemble the Superlatch backing plate, latch plate and shroud. The backing plate is reversible for left and right hand gates, ensure the latch moves vertically up and drops back down. A spring is supplied which is recommended to fit to ensure the latch will always return.
6. Fit the lock assembly over the spindle and fix with 4 screws.
7. Fix the keep plate to the gate post so it engages with the latch.

DRILLING GUIDE SUPPLIED WITH THE LOCK

LOCK CODE:

C _____

TO CHANGE THE CODE

1. Check the original code is working on the keypad.
2. Turn the keypad over and remove the 4 screws.
3. Lift off the covering panel carefully as there are 14 springs attached to this panel. Note that the red tumblers relate to the code shown above. Also note that the C tumbler is uncoloured and should not be removed.
4. To change the code, hold the keypad with the code buttons facing downwards and depress & hold the C button (if this is not done you may damage some of the internal components). Reposition the tumblers to the new code (red tumblers are coded and blue tumblers are uncoded). Ensure that the square cut-out on each tumbler is facing the outside of the lock body, also ensure that the coloured mark is facing upwards. If any one tumbler is upside down or the wrong way round the lock will not work and if forced will break the internal components. The code must always start with a 'C'.
5. Replace the covering panel and tighten the 2 screws
6. The code is now changed, check to see that it is working correctly and make a note of the code for future reference.

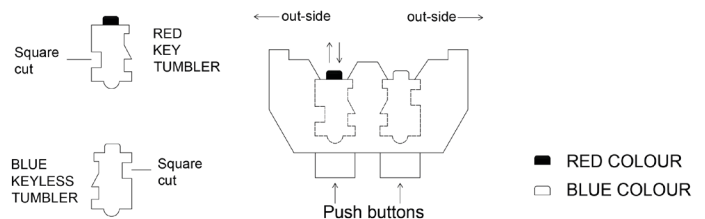

MAINTENANCE

6 monthly:

1. Remove keypad from the gate.
2. Spray the inside of the lock thoroughly with WD40 or equivalent, through the tumbler holes at the back of the lock.
3. Spray all the fixing accessories and the latch with WD40 or equivalent.
4. Push each of the buttons and rotate the knob several times to make sure the lock is working smoothly.

GATEMASTER

VISIT GATEMASTERLOCKS.COM FOR MORE
INFORMATION



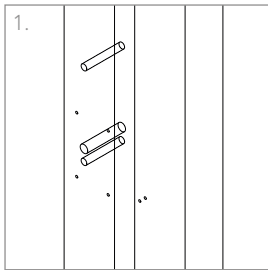

1. Drill 3 holes through for the keypad using template below. Pilot drill screw holes if necessary.

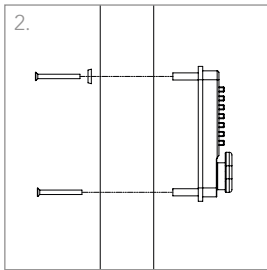

2. Fit outside keypad using screws and extenders if required.

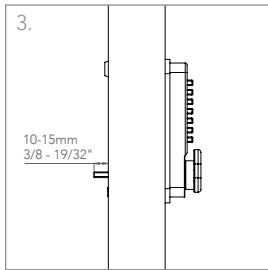

3. Insert the spindle. Cut to length if it protrudes more than the dimension shown.

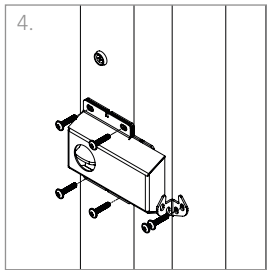

4. Screw the lock on.

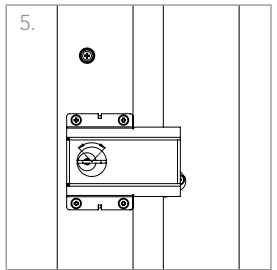

5. Test latch to ensure smooth operation.

DRILL 9mm THRU
[3/8"]

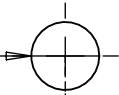

SUGGESTED GATE
EDGE POSITION

SUPPLIED SCREWS HERE

DRILL 12mm THRU
[1/2"]

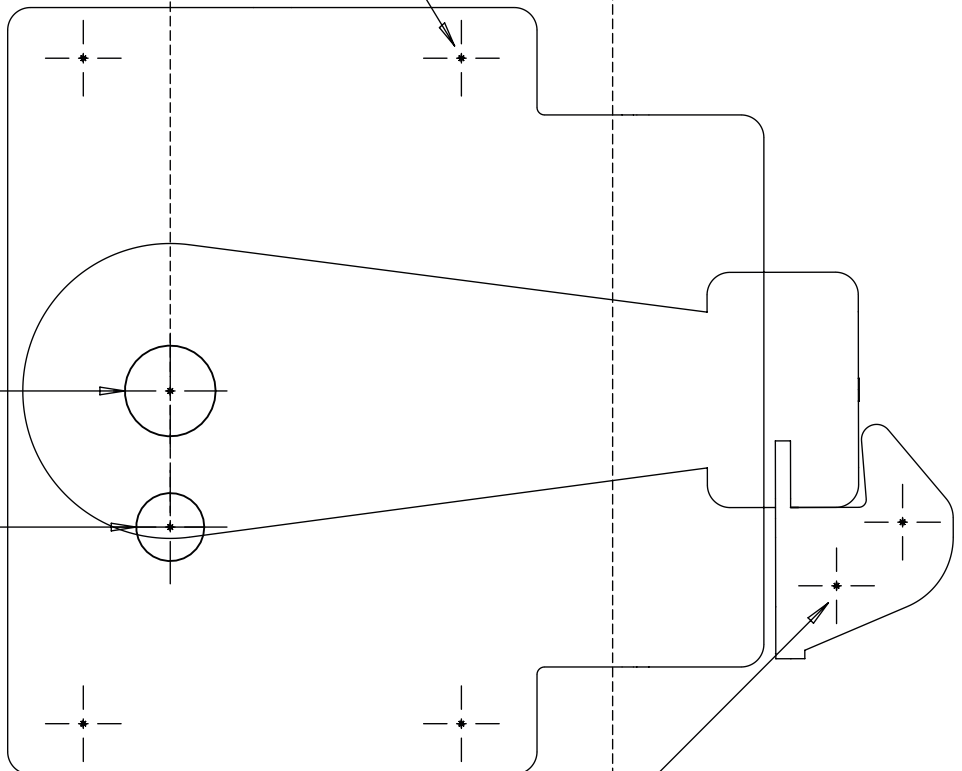

DRILL 9mm THRU
[3/8"]

SUPPLIED SCREWS HERE

SUGGESTED GATE
EDGE POSITION

DRILL 9mm THRU
[3/8"]

SUPPLIED SCREWS HERE

